

Product Summary

$V_{DS} = 1200\text{ V}$
 $I_D@25^\circ\text{C} = 69\text{ A}$
 $R_{DS(ON)} = 33\text{ m}\Omega$

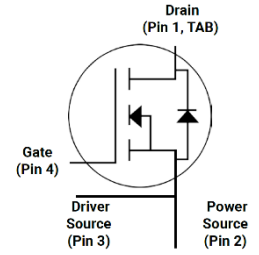
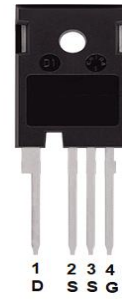

TO-247-4

Features

- High Blocking Voltage
- High Frequency Operation
- Low on-resistance
- Fast intrinsic diode with low reverse recovery
- 100% avalanche tested

Benefits

- Higher System Efficiency
- Parallel Device Convenience without thermal runaway
- High Temperature Application
- Hard Switching & Higher Reliability
- Easy to drive

Applications

- Motor Drives
- Solar / Wind Inverters
- EV Charging Station
- AC/DC converters
- DC/DC converters
- Uninterruptable power supplies

Maximum Ratings ($T_C=25^\circ\text{C}$ unless otherwise specified)

Parameter	Symbol	Test conditions	Value	Unit
Drain - Source Voltage	V_{DSmax}	$V_{GS}=0\text{V}$, $I_D=100\mu\text{A}$	1200	V
Gate - Source Voltage (dynamic)	V_{GSmax}	AC ($f>1\text{ Hz}$)	-10 / +25	V
Gate - Source Voltage (static)	V_{GSop}	static	-5 / +20	V
Continuous Drain Current	I_D	$V_{GS} = 20\text{V}$, $T_C=25^\circ\text{C}$ $V_{GS} = 20\text{V}$, $T_C=100^\circ\text{C}$	69 49	A
Pulsed Drain Current	$I_{D(pulse)}$	$T_C=25^\circ\text{C}$	114	A
Total power dissipation	P_D	$T_C=25^\circ\text{C}$	300	W
Avalanche Capability	E_{AS}	$V_{DD} = 100\text{V}$, $V_{GS}=20\text{V}$, $L=2\text{mH}$	576	mJ
Avalanche Capability	I_{AV}	$V_{DD} = 100\text{V}$, $V_{GS}=20\text{V}$, $L=2\text{mH}$	24	A
Operating Junction Temperature	T_J		-55 to 175	$^\circ\text{C}$
Storage Temperature	T_{STG}		-55 to 175	$^\circ\text{C}$

Stresses exceeding those listed in the Maximum Ratings table may damage the device. If any of these limits are exceeded, device functionality should not be assumed, damage may occur and reliability may be affected.

Electrical Characteristics ($T_C=25^{\circ}\text{C}$ unless otherwise specified)

Parameter	Symbol	Test conditions	Min	Typ	Max	Unit
Drain-Source Breakdown Voltage	$V_{(BR)DSS}$	$V_{GS} = 0V, I_D = 100\mu A$	1200			V
Gate Threshold Voltage	$V_{GS(th)}$	$V_{DS} = V_{GS}, I_D = 10mA$	1.8	2.6	3.7	V
		$V_{DS} = V_{GS}, I_D = 10mA, T_J = 150^{\circ}\text{C}$		1.9		
		$V_{DS} = V_{GS}, I_D = 10mA, T_J = 175^{\circ}\text{C}$		1.8		
Zero Gate Voltage Drain Current	I_{DSS}	$V_{DS} = 1200V, V_{GS} = 0V$	0	1	50	μA
Gate-Source Leakage Current	I_{GSS}	$V_{GS} = 20V, V_{DS} = 0V$	0	1	200	nA
Gate-Source Leakage Current	I_{GSS}	$V_{GS} = -5V, V_{DS} = 0V$	-200	-1	0	nA
Drain-Source On-State Resistance	$R_{DS(on)}$	$V_{GS} = 20V, I_D = 40 A$		33	45	m Ω
		$V_{GS} = 20V, I_D = 40 A, T_J = 150^{\circ}\text{C}$		50		
		$V_{GS} = 20V, I_D = 40 A, T_J = 175^{\circ}\text{C}$		56		
		$V_{GS} = 18V, I_D = 40 A,$		37		
Transconductance	g_{fs}	$V_{DS} = 20V, I_D = 40 A,$		24		S
		$V_{DS} = 20V, I_D = 40 A, T_J = 150^{\circ}\text{C}$		22		
		$V_{DS} = 20V, I_D = 40 A, T_J = 175^{\circ}\text{C}$		22		
Input capacitance	C_{iss}	$V_{DS} = 1000V, V_{GS} = 0V$ $f = 1MHz$		2660		pF
Output capacitance	C_{oss}			128		
Reverse transfer capacitance	C_{rss}			9		
C_{oss} Stored Energy	E_{oss}			84		
Total gate charge	Q_g	$V_{DS} = 800V, V_{GS} = -5V / 20V$ $I_D = 40 A,$		135		nC
Gate-source charge	Q_{gs}			36		
Gate-drain charge	Q_{gd}			53		
Internal gate input resistance	$R_{g(int)}$	$f = 1MHz, I_D = 0A$		2.4		Ω
Turn-On Switching Energy	E_{ON}	$V_{DS} = 800 V, V_{GS} = -5V/20V,$ $I_D = 40A, R_{G(ext)} = 2\Omega,$ $L = 100\mu H$		532		μJ
Turn-Off Switching Energy	E_{OFF}			24		
Turn-On Delay Time	$t_{d(on)}$			32		ns
Rise Time	t_r			18		
Turn-Off Delay Time	$t_{d(off)}$			41		
Fall Time	t_f			9		

Reverse Diode Characteristics ($T_C=25^{\circ}\text{C}$ unless otherwise specified)

Parameter	Symbol	Condition	Min	Typ	Max	Unit
Diode Forward Voltage	V_{SD}	$V_{GS} = -5\text{V}, I_{SD} = 20\text{A},$		4.6		V
		$V_{GS} = -5\text{V}, I_{SD} = 20\text{A},$ $T_J = 150^{\circ}\text{C}$		4.1		
		$V_{GS} = -5\text{V}, I_{SD} = 20\text{A},$ $T_J = 175^{\circ}\text{C}$		4.0		
Continuous Diode Forward Current	I_S	$V_{GS} = -5\text{V}$			55	A
Reverse Recovery time	t_{rr}	$V_{GS} = -5\text{V}, I_{SD} = 40\text{A},$ $V_R = 800\text{V}, \text{dif}/\text{dt} = 3400 \text{ A}/\mu\text{s}$		19		ns
Reverse Recovery Charge	Q_{rr}			330		nC
Peak Reverse Recovery Current	I_{rrm}			31		A

Thermal Characteristics

Parameter	Symbol	Condition	Min	Typ	Max	Unit
Thermal Resistance (per device)	$R_{th(j-c)}$	junction-case		0.4	0.5	$^{\circ}\text{C}/\text{W}$

Typical Performance

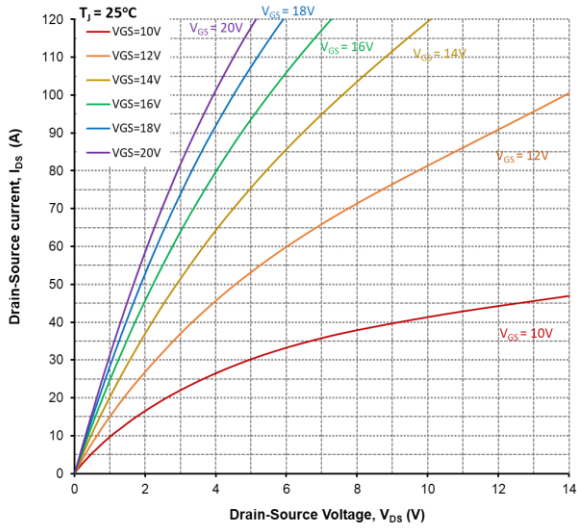

Figure 1. Output Characteristics, $T_J = 25^\circ\text{C}$

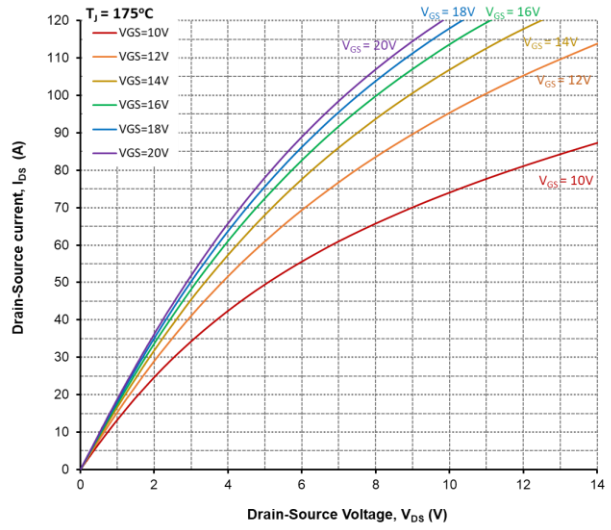

Figure 2. Output Characteristics, $T_J = 175^\circ\text{C}$

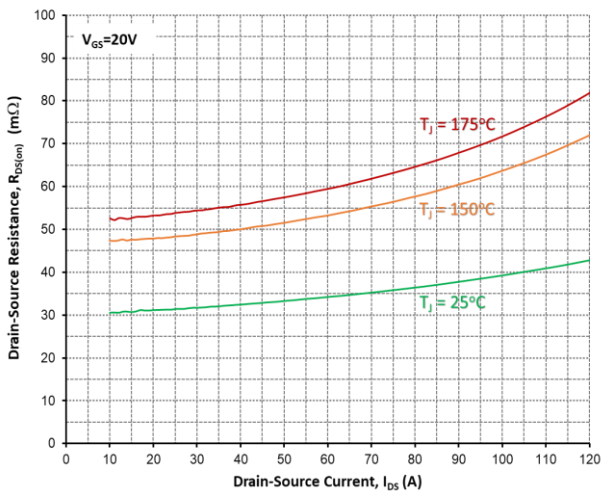

Figure 3. On-Resistance vs. Drain Current For Various Temperatures

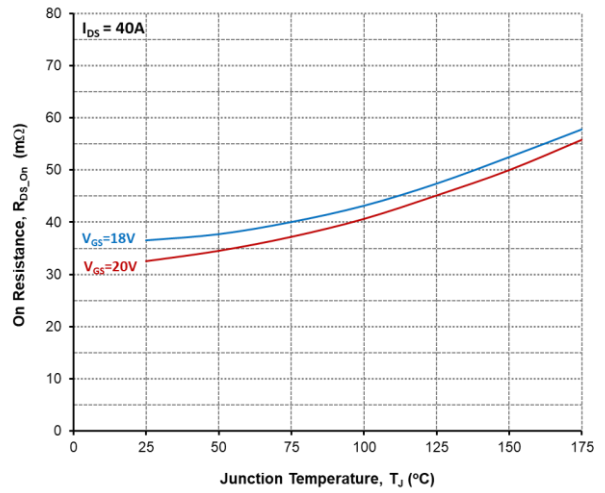

Figure 4. On-Resistance vs. Temperature

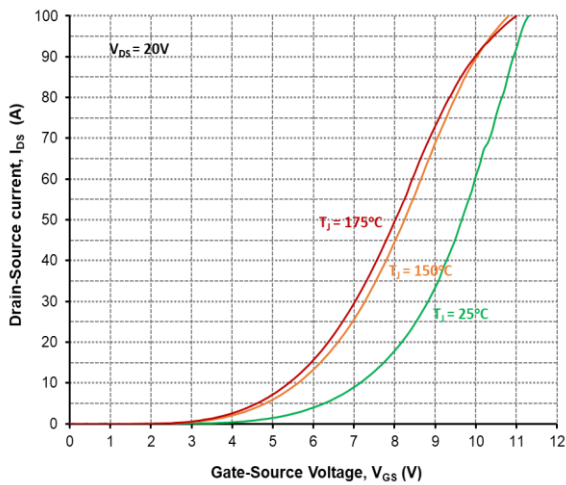

Figure 5. Transfer Characteristic For Various Junction Temperatures

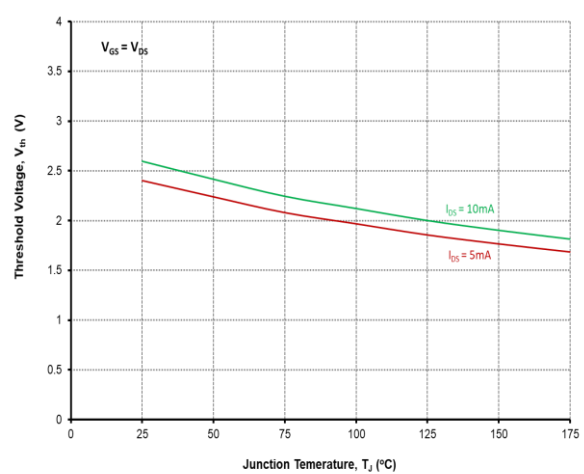

Figure 6. Threshold Voltage vs. Temperature

Typical Performance

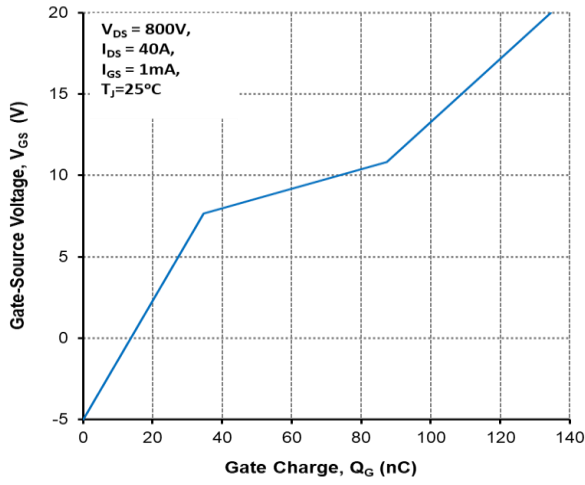

Figure 7. Gate Charge Characteristics

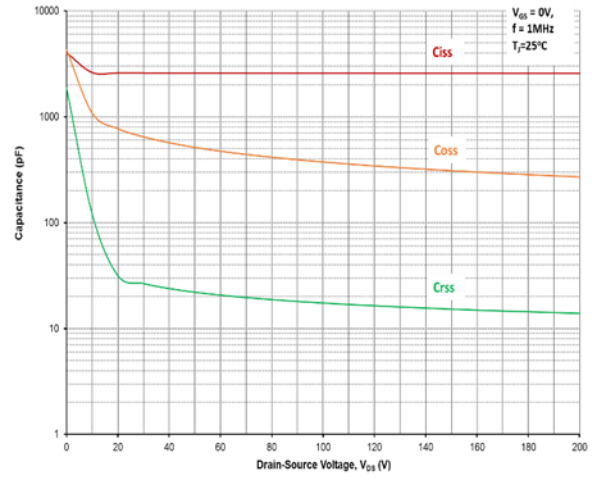

Figure 8. Capacitances vs. Drain-Source Voltage (0-200V)

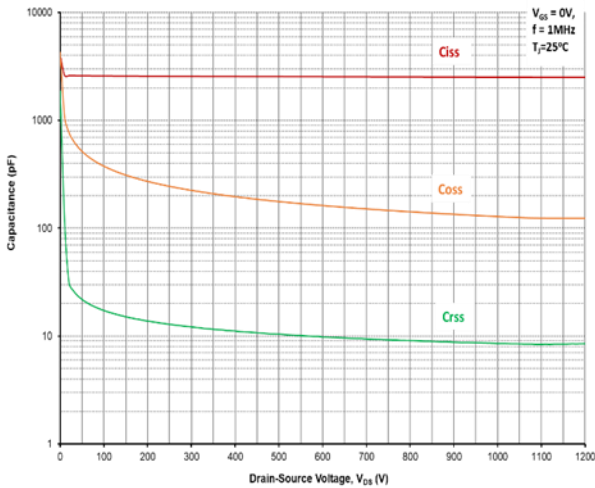

Figure 9. Capacitances vs. Drain-Source Voltage (0-1200V)

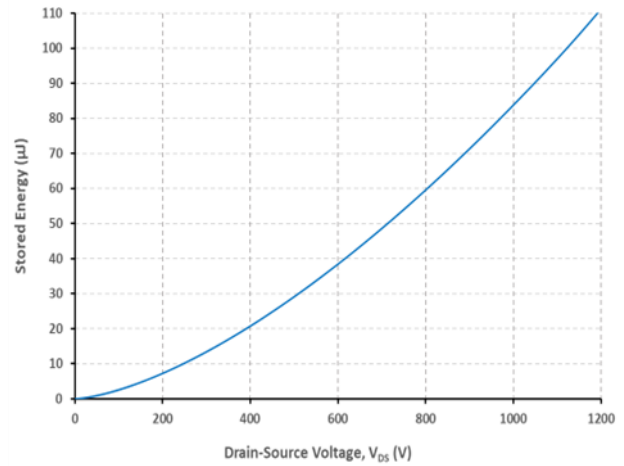

Figure 10. Output Capacitor Stored Energy

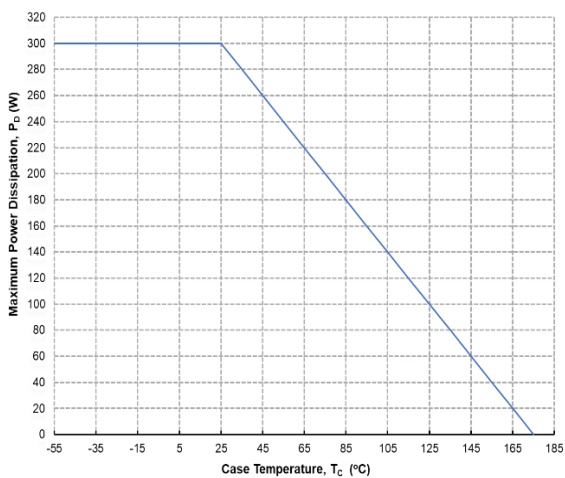

Figure 11. Maximum Power Dissipation Derating vs. Case Temperature

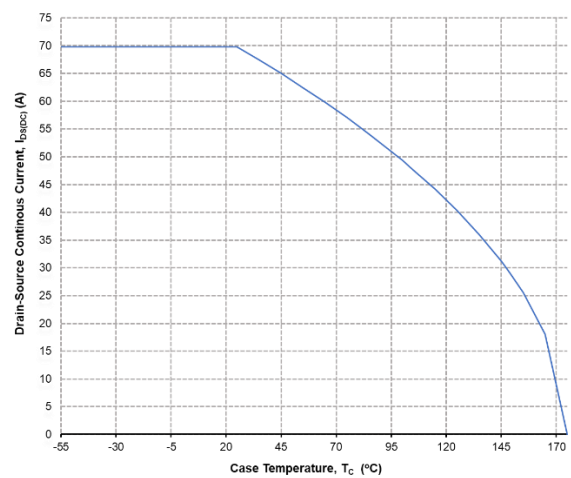

Figure 12. Continuous Drain Current Derating vs. Case Temperature

Typical Performance

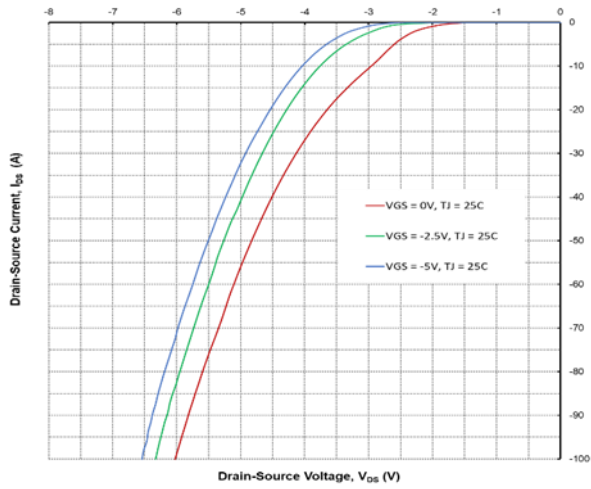

Figure 13. Body Diode Characteristics @ 25°C

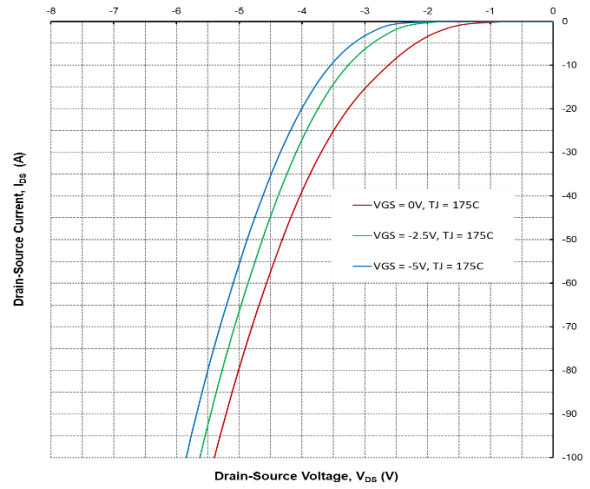

Figure 14. Body Diode Characteristics @ 175°C

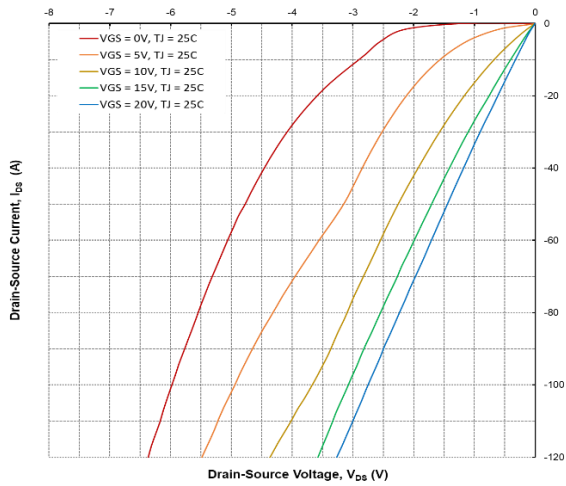

Figure 15. 3rd Quadrant Characteristics @ 25°C

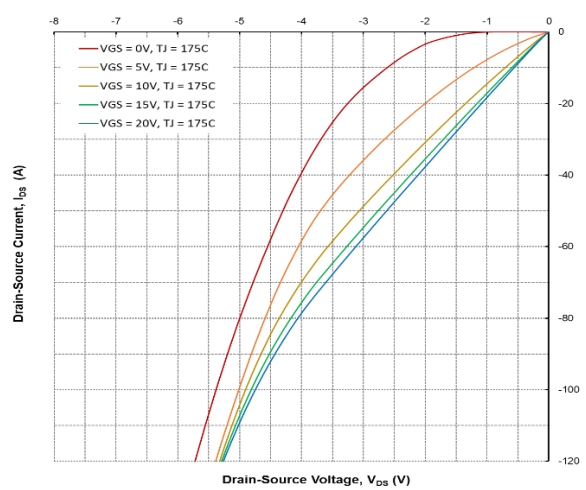

Figure 16. 3rd Quadrant Characteristics @ 175°C

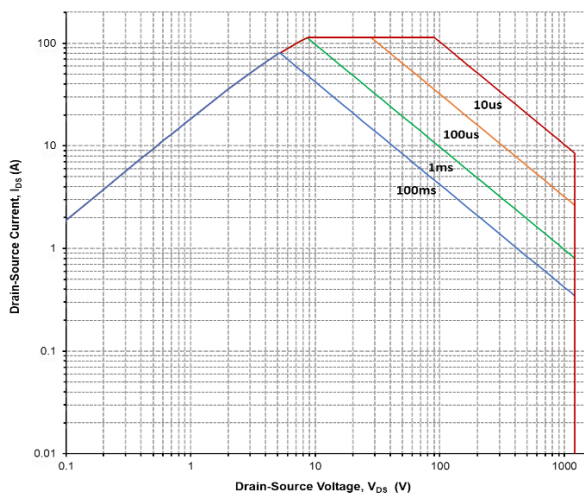

Figure 17. Safe Operating Area

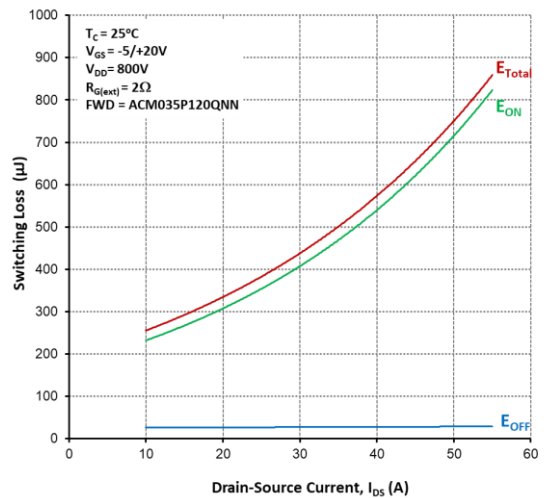

Figure 18. Switching energy vs Drain current

Typical Performance

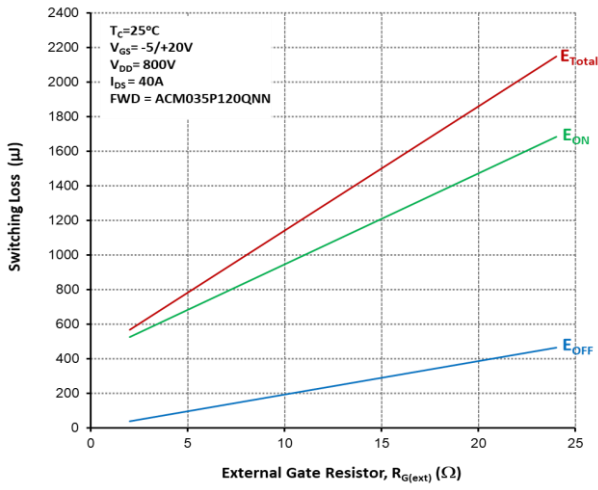

Figure 19. Switching energy vs External Gate Resistor

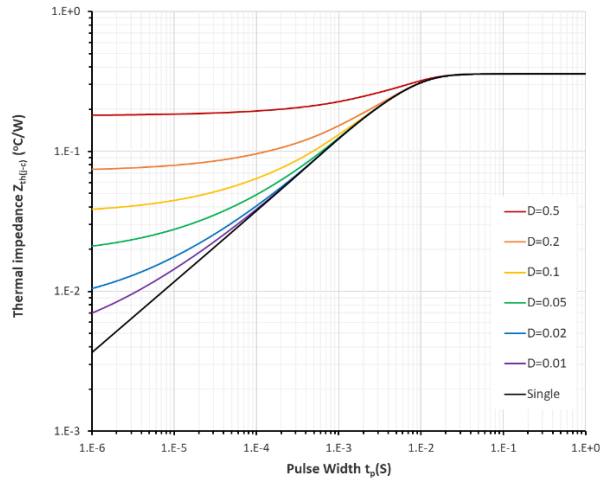

Figure 20. Transient Thermal Impedance (Junction to Case)

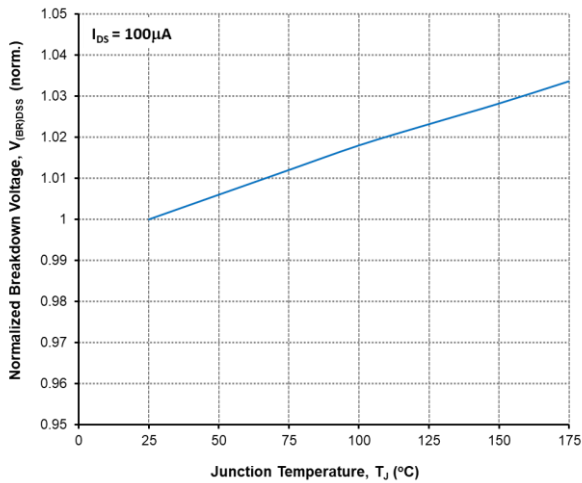
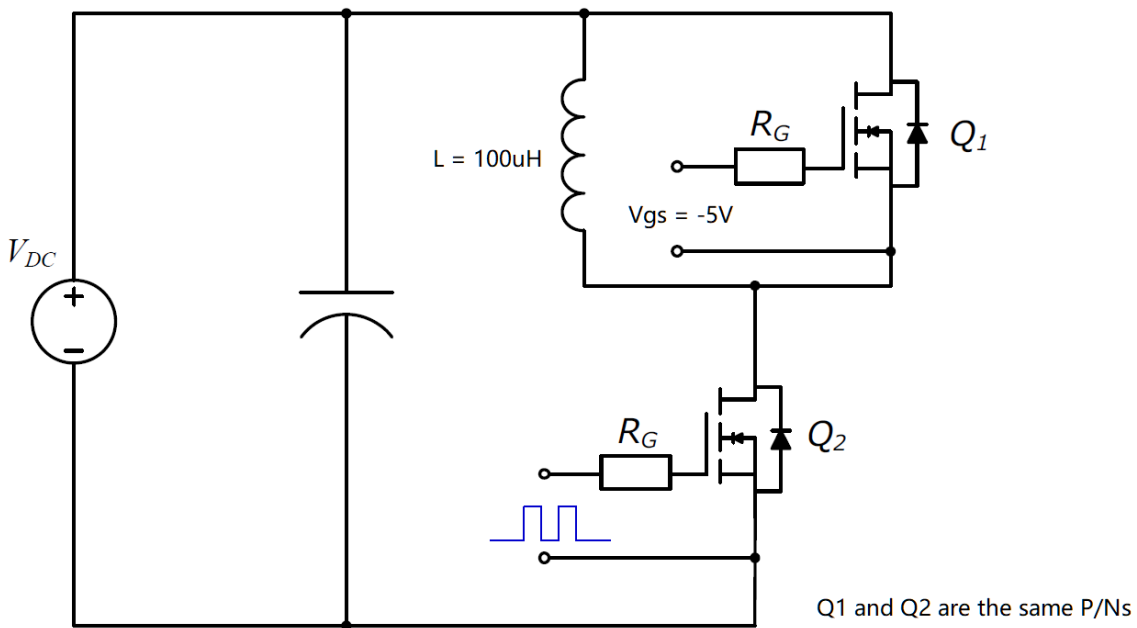
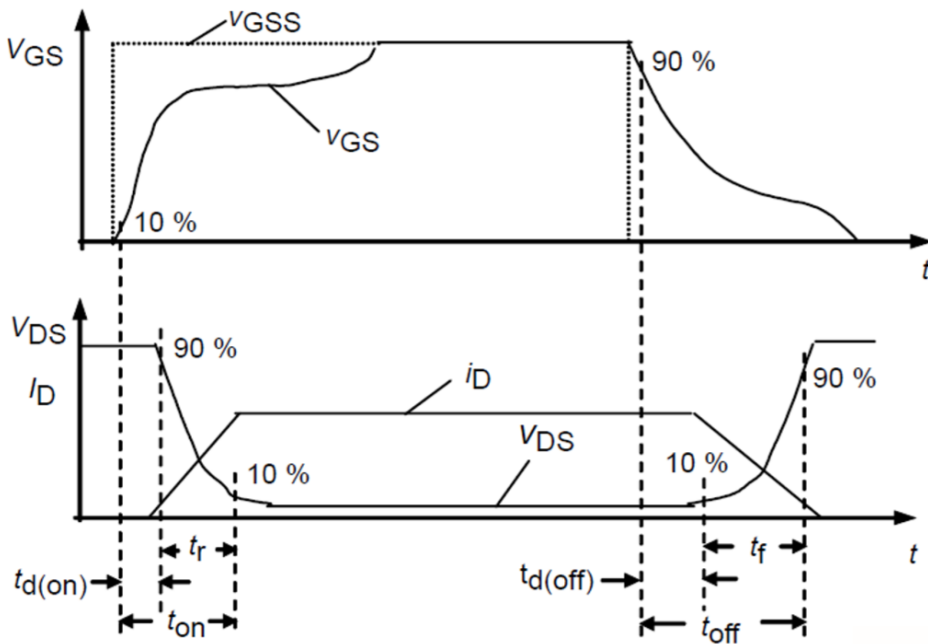

Figure 21. Normalized breakdown voltage vs Temperature

Switching Times Definition and Test Circuit



Package Dimensions

(TO-247-4 Package)

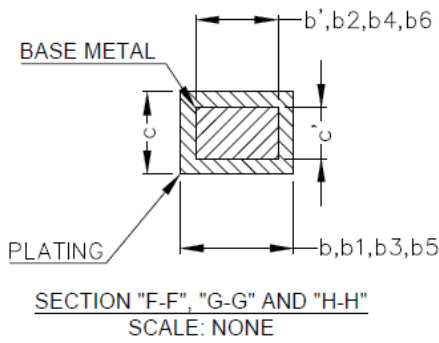
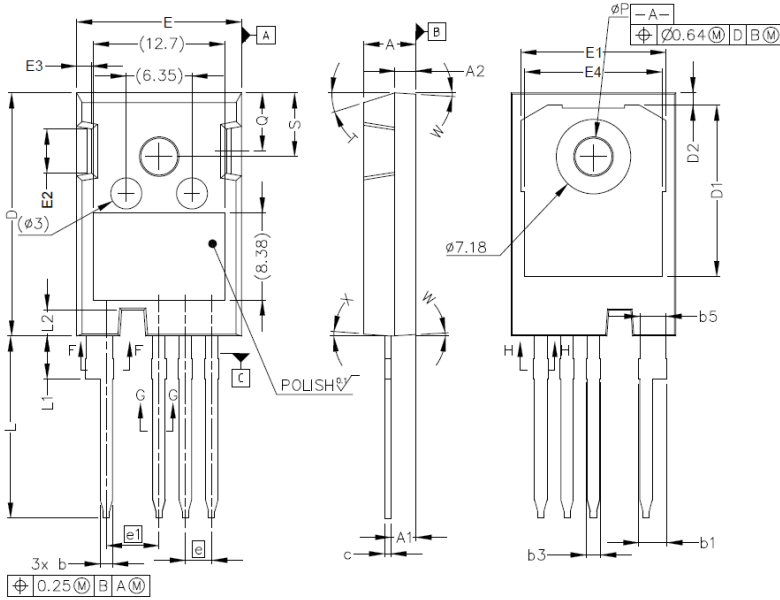

SYMBOL	MILLIMETERS	
	MIN	MAX
A	4.83	5.21
A1	2.29	2.54
A2	1.91	2.16
b'	1.07	1.28
b	1.07	1.33
b1	2.39	2.94
b2	2.39	2.84
b3	1.07	1.60
b4	1.07	1.50
b5	2.39	2.69
b6	2.39	2.64
c'	0.55	0.65
c	0.55	0.68
D	23.30	23.60
D1	16.25	17.65
D2	0.95	1.25
E	15.75	16.13
E1	13.10	14.15
E2	3.68	5.10
E3	1.00	1.90
E4	12.38	13.43
e	2.54 BSC	
e1	5.08 BSC	
N	4	
L	17.31	17.82
L1	3.97	4.37
L2	2.35	2.65
øP	3.51	3.65
Q	5.49	6.00
S	6.04	6.30
T	17.5° REF.	
W	3.5° REF.	
X	4° REF.	

NOTE :
 1. ALL METAL SURFACES: TIN PLATED, EXCEPT AREA OF CUT
 2. DIMENSIONING & TOLERANCING CONFIRM TO ASME Y14.5M-1994.
 3. ALL DIMENSIONS ARE IN MILLIMETERS. ANGLES ARE IN DEGREES.